



ROHDE & SCHWARZ

Test and Measurement Division

FSH View

Software for FSH Spectrum Analyzers

Users Manual

April 2004

© 2002, 2004 Rohde & Schwarz Company. All rights reserved.
All product names are trademarks of their respective companies.

Table of Contents

Title	Page
Installing FSH View	1
Installing the FSH View Software.....	1
Running the FSH View Software	1
Connecting the Spectrum Analyzer	2
Using FSH View	3
Using Online Help	3
Introducing the FSH View Software	4
Menu Commands	4
Toolbar Buttons.....	7
Left Half Toolbar	7
Right Half Toolbar	7
Instrument Screens	8
Sweeps.....	9
Instrument Datasets	10
Cable Models	11
Limit Lines	12
Transducer Factors	13
Channel Tables.....	14
Creating a Test Report.....	15
Documenting Screens	17
Displaying an Instrument Screen on the PC.....	17
Inserting Screens into a Document.....	18
Analyzing Sweeps	19
Displaying Sweeps on the PC	19
Changing Sweep Settings.....	22
Zooming In and Out on a Trace	22
Inserting Sweep Data into a Spreadsheet	22
Transferring Instrument Datasets	23
Saving Datasets to the PC	23
Uploading Datasets to the Instrument	24

Using Cable Models for Distance To Fault	26
Uploading Cable Models to the Instrument	26
Editing Cable Models	27
Using Limit Lines.....	29
Uploading Limit Lines to the Instrument.....	29
Editing Limit Lines	29
Using Transducer Factors	32
Uploading Transducer Factors to the Instrument	32
Editing Transducer Factors.....	32
Using Channel Tables	35
Uploading Channel Tables to the Instrument	35
Editing Channel Tables.....	35
Printing Windows.....	38
Printing a Window	38
Printing Multiple Windows on a Page.....	38
Saving to a File.....	40
Optically Isolated RS-232 Interface (optional)	41
Interface Connections.....	41
Interface Specifications.....	42
Interface Cable	43
Index	44

Chapter 1

Installing FSH View

Installing the FSH View Software

FSH View software offers you simple mouse-controlled tools to work with your Spectrum Analyzer.

The setup program installs the FSH View software on PC's running Windows 98, ME (Millennium Edition), NT 4, 2000, and XP.

To install FSH View, insert the CD ROM into the CD ROM drive and choose **Install FSH View**.

To install FSH View from floppy after you created floppies from the CD ROM, insert the first floppy in the appropriate floppy disk drive and run **Setup.exe**.

The setup program starts up and prompts you for information to complete the installation.

Running the FSH View Software



Choose from **Start - Programs - FSH View - FSH View** to run the FSH View software.



Choose from **Start - Programs - FSH View - FSH Report** to create a test report in Word.

Connecting the Spectrum Analyzer

The FSH View software communicates with your Spectrum Analyzer via the optically isolated RS-232 adapter/cable connected to a COM port of the PC (see Appendix).

During startup (except for the first time), the FSH View software automatically tries to make a connection with the instrument according to the last valid connection.

If automatic connection is not successful, the dialog box shown below appears, allowing you to make a connection.

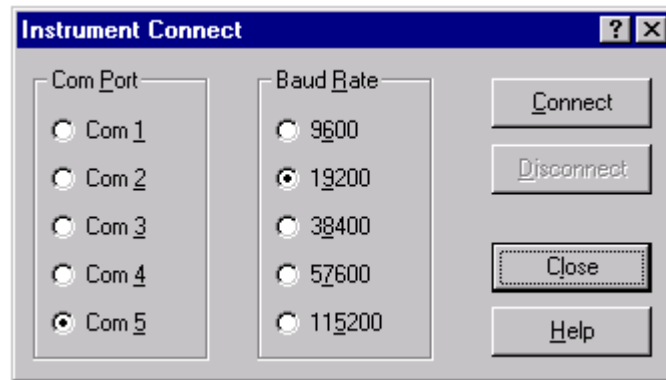





- 1 Select the **Com Port** that connects the instrument to the PC.
- 2 Select the desired **Baud Rate**.
FSH View will automatically select a lower baud rate if connection cannot be established at the selected baud rate.
- 3 Click **Connect** to establish a connection with the instrument.

Chapter 2 Using FSH View

Using Online Help

The FSH View software offers you access to online help by using the **F1** key, a **Help** button, “**What’s This?**” help, or the **Help** menu:

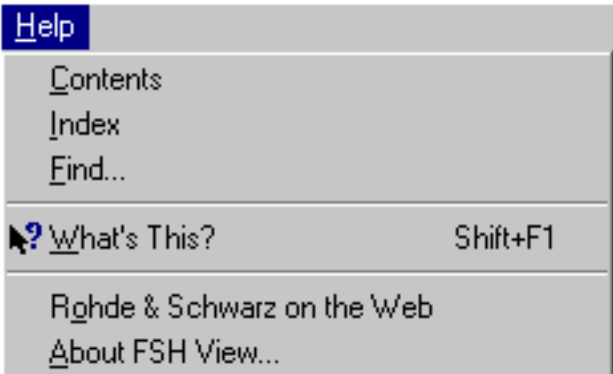
 or Shift+ 	Press to get online help for the topic that has the focus.
 or 	Click, move the mouse pointer on a topic, and click again to get “What’s This” help.
	Click to get help.
	For example: Click Help - Contents and select a topic from the contents list.





Note

To show help items on a help page, do one of the following:











- move the mouse pointer (changes to  over a help item);
- press **Tab** (changes the background of a help item).

Introducing the FSH View Software



Menu Commands

File	File menu commands:
 O pen... Ctrl+O	Opens a file
C lose	Closes the active window
 S ave As... Ctrl+S	Saves window(s) to a file
P age Setup...	Allows you to configure a page
P rint Setup...	Allows you to setup a printer
 P rint P review...	Previews the page (multiple windows)
 P rint Ctrl+P	Prints the page
E xit	Exits the FSH View software





Edit	Edit menu commands:
 C opy G raphics Ctrl+G	Copies window bitmap data to clipboard
C opy D ata	Copies numerical sweep data to clipboard
C opy S weep...	Copies the active window sweep into another identical sweep window
D elete S weep	Deletes the active window sweep

Instrument	Instrument menu commands:
 D isplay S creen Ctrl+I	Displays the active screen
 D isplay S weep Ctrl+W	Displays the active sweep
 M ultiple T ransfers...	Displays multiple sweeps
 D ataset C ontrol...	Allows you to transfer datasets
 C able M odel C ontrol...	Allows you to transfer cable models
 L imit L ine C ontrol...	Allows you to transfer limit lines
 T ransducer C ontrol...	Allows you to transfer transducer factors
 C hannel T able C ontrol...	Allows you to transfer channel tables
 C onnect...	Connects the instrument
 D isconnect...	Disconnects the instrument

View

		View menu commands:
Select <u>M</u> arkers...	Ctrl+M	Selects sweep markers + data
✓ View Display <u>L</u> ine	Ctrl+L	Shows/hides the display line
✓ View Trace <u>I</u> nformation	Ctrl+A	Shows/hides sweep trace data
✓ View Status <u>I</u> nformation	Ctrl+U	Shows/hides sweep status data
✓ View Description	Ctrl+D	Shows/hides the description
✓ View <u>G</u> rid		Shows/hides the sweep grid
<u>A</u> ctive Sweep...		Selects the active sweep
All <u>Y</u> scales		Selects all Y-scales or only the Y-scale of the active sweep
 <u>Z</u> oom In	Ctrl+Z	Zooms in on the window trace(s)
 <u>Z</u> oom Out		Zooms out on the window trace(s)
 <u>Z</u> oom <u>R</u> eset	Ctrl+R	Undoes all previous zoom steps
✓ <u>T</u> oolbar		Shows/hides the tool bar
✓ <u>S</u> tatusbar		Shows/hides the status bar

Tools

		Tools menu commands:
 <u>C</u> able Model Editor...		Allows you to edit cable model data
 <u>L</u> imit Line Editor...		Allows you to edit limit line data
 <u>T</u> ransducer Editor...		Allows you to edit transducer factor data
 <u>C</u> hannel Table Editor...		Allows you to edit channel table data

Options

		Options menu commands:
<u>D</u> escription...		Allows you to change the number of text characters on a description line
<u>C</u> olors...		Allows you to change window colors
<u>T</u> itles... Ctrl+T		Allows you to change window titles
<u>S</u> weep Settings...		Allows you to change active sweep settings

Window

		Window menu commands:
Cascade	Shift+F5	Arranges windows in a cascading pattern
Tile Horizontal	Shift+F4	Arranges windows one above another
Tile Vertical	Shift+F6	Arranges windows side by side
Auto Tile		Automatically arranges windows
Arrange Icons		Automatically arranges icons (minimized windows)
Default Size		Sets the active window to its initial height and width
Close	Ctrl+F4	Closes the active window
Close All		Closes all windows

Help

		Help menu commands:
Contents		Shows online help contents
Index		Shows online help index
Find...		Enables you to find text in the online help
? What's This?	Shift+F1	Enables the "What's This?" help information
Rohde & Schwarz on the Web		Activates the Rohde & Schwarz web site
About FSH View...		Shows information about the FSH View software

Toolbar Buttons



By clicking the buttons on the toolbar, you can transfer data directly from/to the Spectrum Analyzer or process the data.

Left Half Toolbar

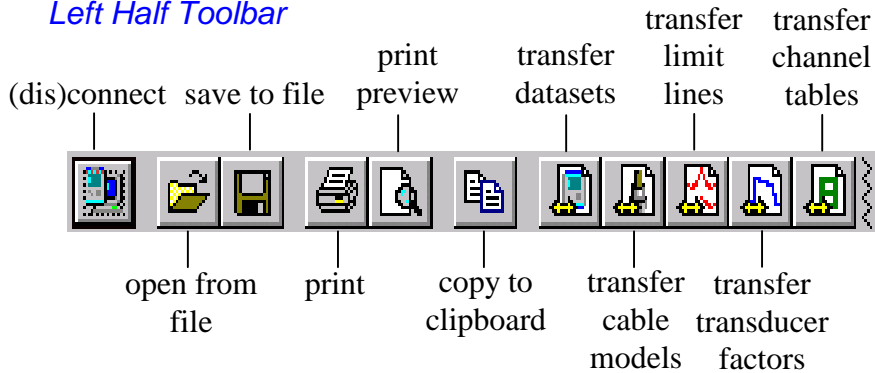

Right Half Toolbar

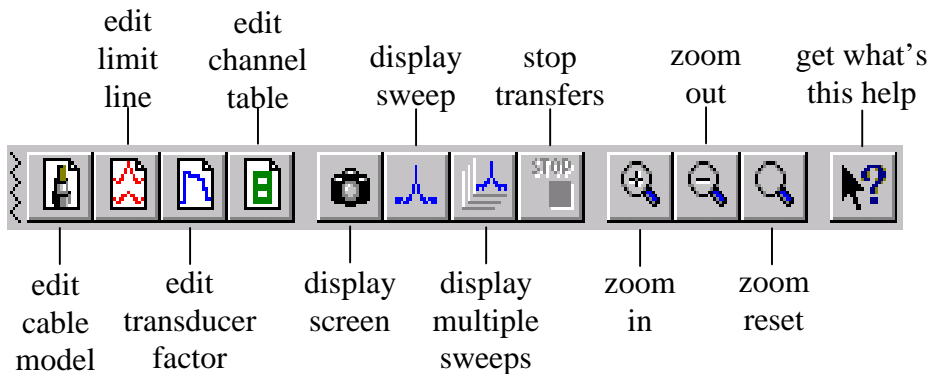

Instrument Screens



Type: bitmap graphics from the instrument screen (pixel-format)

Use: to create documents and reports

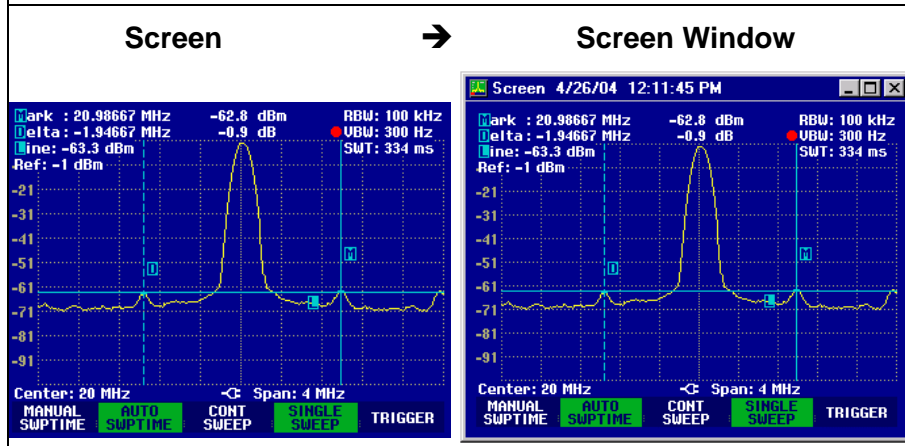

Refer to [Documenting Screens](#).

Sweeps



Type: numerical trace points to generate graphs

Use: to analyze by means of zooming or export to spreadsheets

Sweep on instrument →

Sweep Window

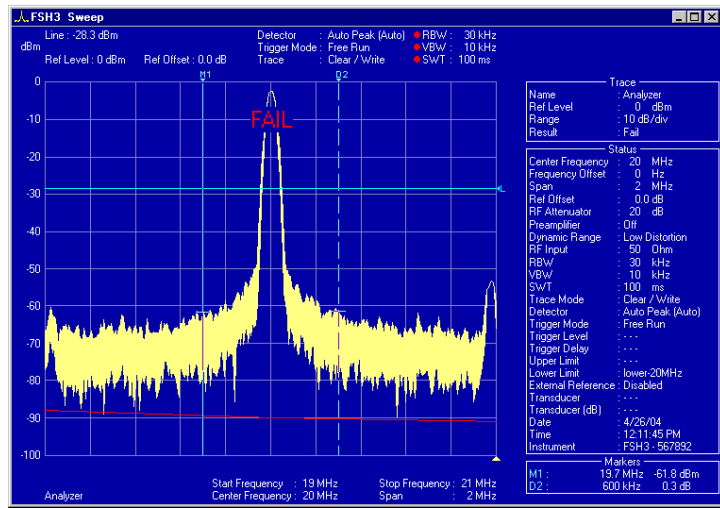
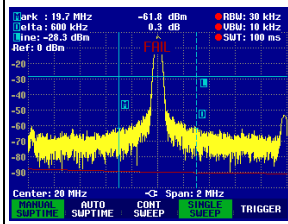

Refer to [Analyzing Sweeps](#).

Instrument Datasets



Type: sweep and setup data

Use: to retrieve and send back instrument datasets

Dataset **↔** **Dataset file(s)**

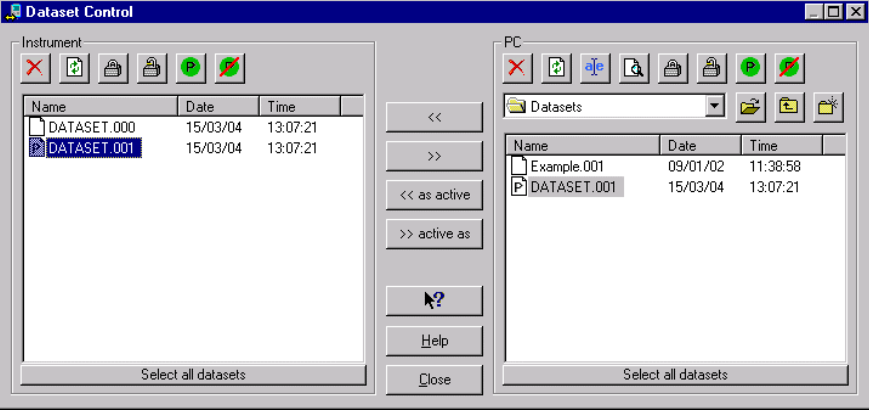



Name	Date	Time
DATASET.000	15/03/04	13:07:21
DATASET.001	15/03/04	13:07:21

Name	Date	Time
Example.001	09/01/02	11:38:58
DATASET.001	15/03/04	13:07:21

Refer to [Transferring Instrument Datasets](#).

Cable Models

Type: cable model data

Use: to retrieve, edit, and send back instrument cable models

Cable model **↔** **Cable model file(s)**

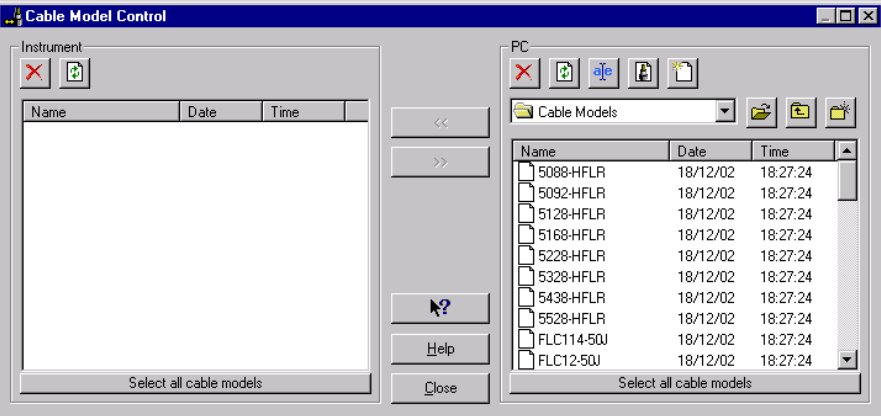

The screenshot shows the 'Cable Model Control' window. It has two main panes: 'Instrument' on the left and 'PC' on the right. Both panes have a table with columns for 'Name', 'Date', and 'Time'. The 'PC' pane shows a list of cable models with names like '5088-HFLR' and 'FLC114-50J'. Between the panes are navigation buttons: '<<', '>>', '?', 'Help', and 'Close'. At the bottom of each pane is a 'Select all cable models' button.

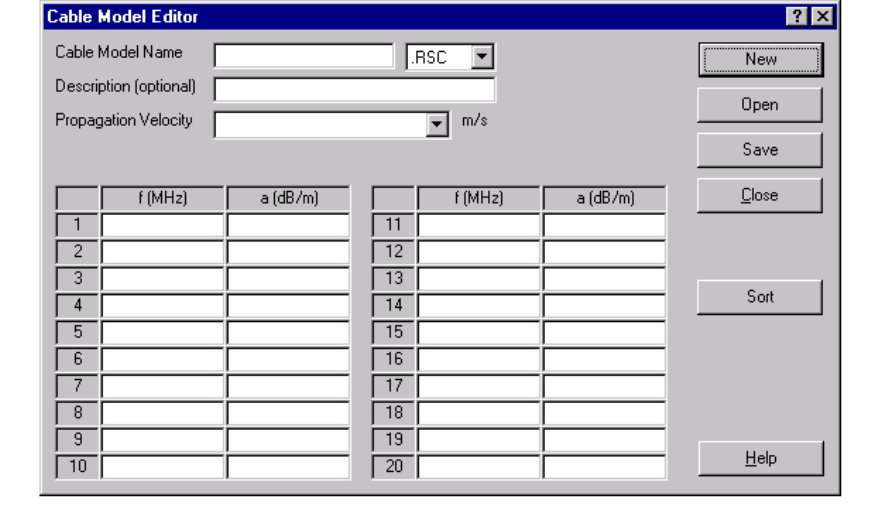

The screenshot shows the 'Cable Model Editor' window. It has input fields for 'Cable Model Name' (with a dropdown set to '.RSC'), 'Description (optional)', and 'Propagation Velocity' (with a dropdown and 'm/s' unit). Below these is a table with 20 rows and 4 columns: 'f (MHz)', 'a (dB/m)', 'f (MHz)', and 'a (dB/m)'. On the right side, there are buttons for 'New', 'Open', 'Save', 'Close', 'Sort', and 'Help'.

Refer to [Using Cable Models](#) for Distance To Fault.

Transducer Factors



Type: transducer factor data

Use: to retrieve, edit, and send back instrument transducer factors

Transducer factor



Transducer factor file(s)

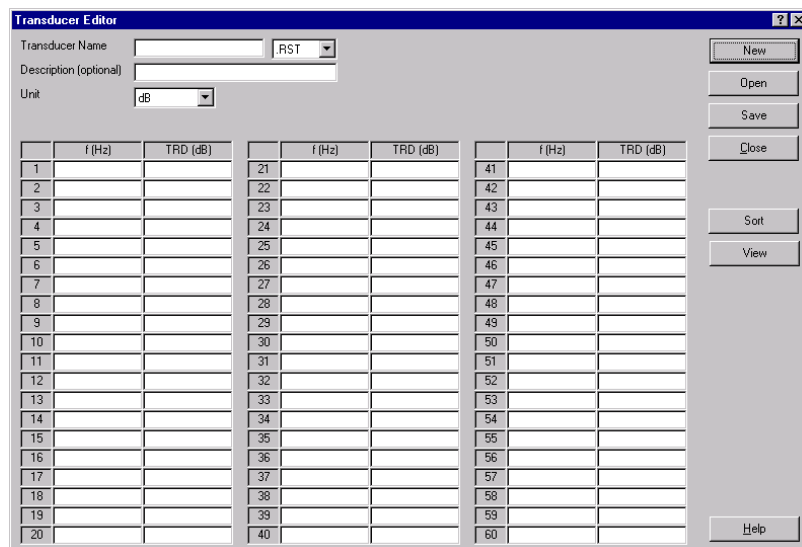
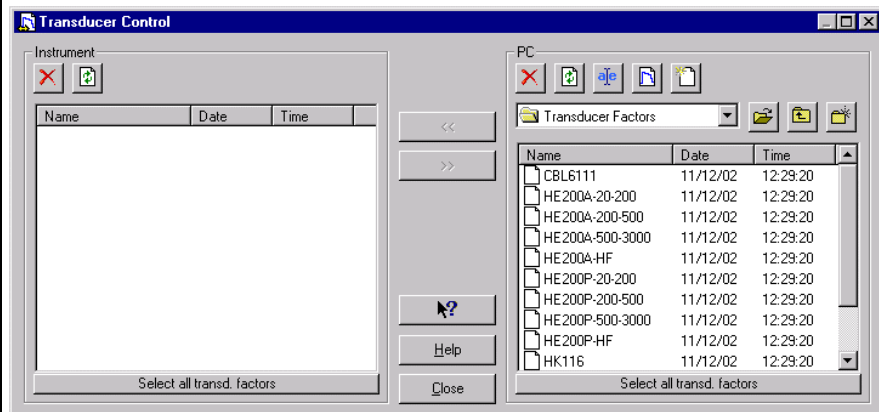

Refer to [Using Transducer Factors](#) to correct sweep points.

Channel Tables

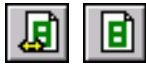

Type: channel table data

Use: to retrieve, edit, and send back instrument channel tables

Channel Table



Channel Table file(s)

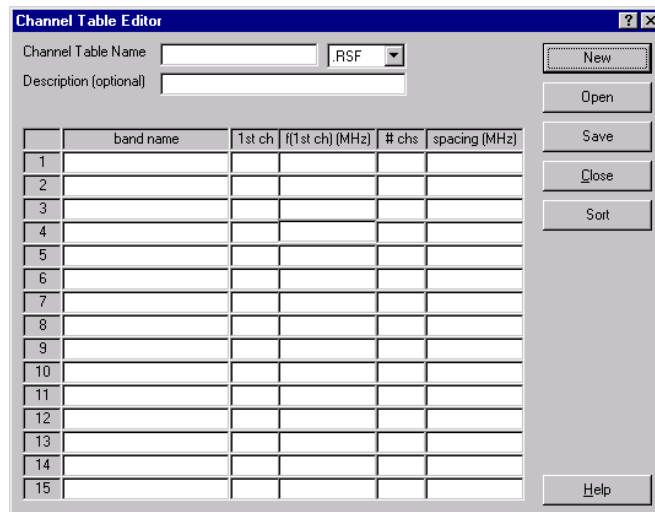
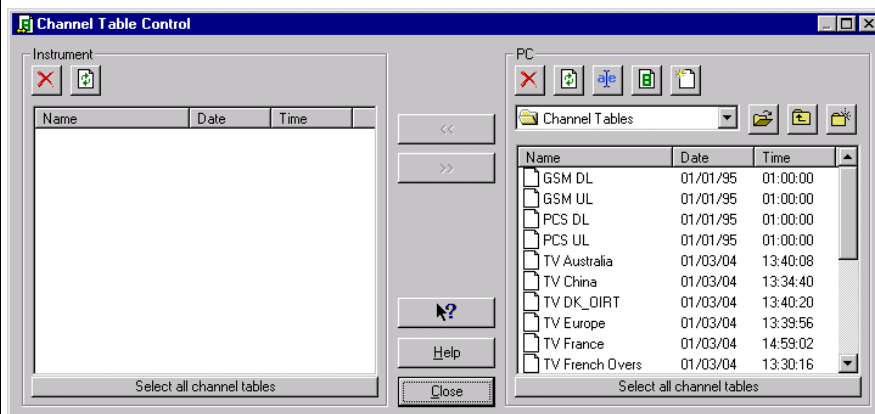



Refer to [Using Channel Tables](#) to define channel numbers for certain frequency bands that you can select in the spectrum analyzer.

Creating a Test Report

- 1  **FSH Report** Choose from **Start - Programs – FSH View** to create a test report.

As a result, Word is started and the required macros are loaded. Select **Enable Macros** when requested.

- 2 Click predefined fields (**Company, Contact, ...**) and type your text.
- 3  Click to insert the active instrument screen in black & white  or color . As a result, FSH View is started, a connection is made, and the active screen is pasted into the document at the position of the mouse cursor.
- 4 Click the **Description** field and type your text.

R&S FSH Test Report

Company: Rohde & Schwarz

Contact: A. Person

Address: Street 3

Zip: 1234 AB

City: München

Phone: 12 345 678910

Fax: 12 345 678911

E-mail: aperson@R&S.com

Date: November 5, 2002

Test Result 1:

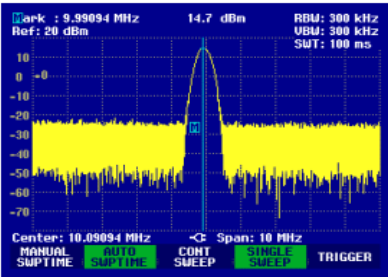





Center Frequency	: 10.09094 MHz
Span	: 10 MHz
Reference Level	: 20 dBm
Reference Offset	: 0.0 dB
RF Attenuator Setting	: 30 dB
RF Input Reference	: 50 Ohm
Resolution Bandwidth	: 300 kHz
Video Bandwidth	: 300 kHz
Sweeptime	: 100 ms
Trigger Mode	: Free Run
Trigger Level	: - - -
Trigger Delay	: - - -
Trace Mode	: Clear / Write
Trace Detector	: Auto Peak
Transducer	: - - -
Transducer (dB)	: - - -

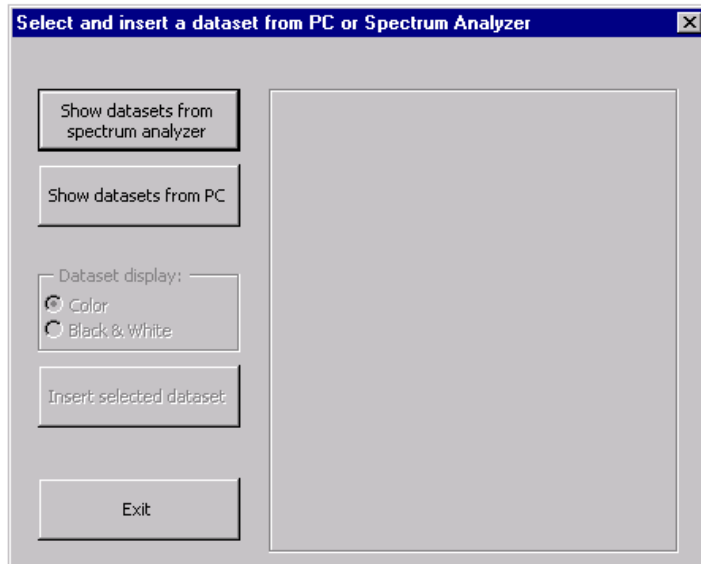

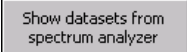
Description:
On these lines you can type your description.

- 5  Click to select and insert dataset pictures into your document.



- 6.1  Click to show the list of dataset names stored in the connected spectrum analyzer and select a dataset from the list.
- 6.2  Click to select and show the dataset files stored in a PC folder (directory).
- 7 Click  **Color** or  **Black & White** to insert datasets in color or Black & White respectively.
- 8  Click to paste the selected dataset into the document at the position of the mouse cursor. Notice that you can also double click a dataset name from the list.

You can paste other dataset pictures by clicking the mouse cursor at new positions in your document.

- 9  Click to close the dialog box.
- 10  Click to print your test report.
- 11  Click to save your test report.

Documenting Screens

Displaying an Instrument Screen on the PC

- 1  Click to display the **active** Spectrum Analyzer screen in a screen window.

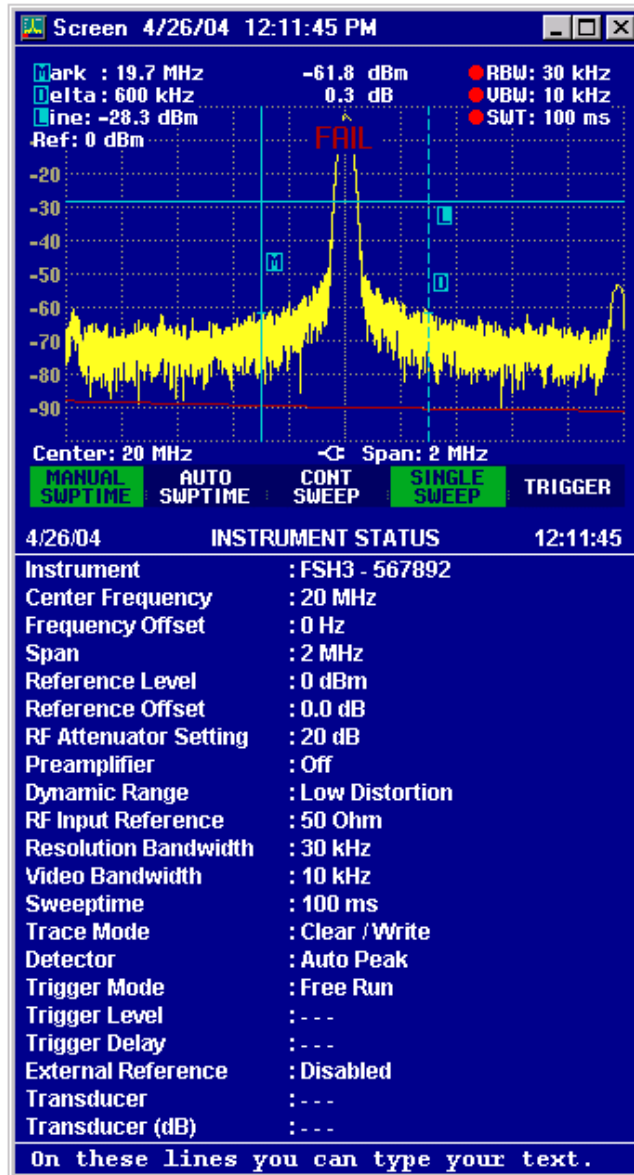

Each Spectrum Analyzer screen appears in a separate screen window. To change the window to your preference:



- 2 Select **View – View Status Information** to view or hide the status block.
- 3 Select **View – View Description** and type a description in the text box below the window (max. 10 lines).
- 4 Select **Options - Description** to change the number of characters on a description line.
- 5 Select **Options - Colors** to display a window in colors or black & white (greyscale).

Inserting Screens into a Document

- 1 Click on the screen window you want to insert.

Tip

To avoid losing resolution because of copying to the clipboard, choose **Window – Default Size**.

- 2  Click to copy the window to the clipboard.
- 3 Switch to a wordprocessor.
- 4 Open or create a document and place the cursor where you want to insert the window.
- 5 Select **Edit - Paste** to insert the screen window into the document.
- 6  Click to save your document.

Note

In the same way, you can insert sweep windows into a document.

Analyzing Sweeps

You can read numerical trace samples from the Spectrum Analyzer and display these samples in a sweep window. Up to four traces can be displayed in a window.

Displaying Sweeps on the PC

- 1  Click to display the active sweep and/or measurement from the instrument.

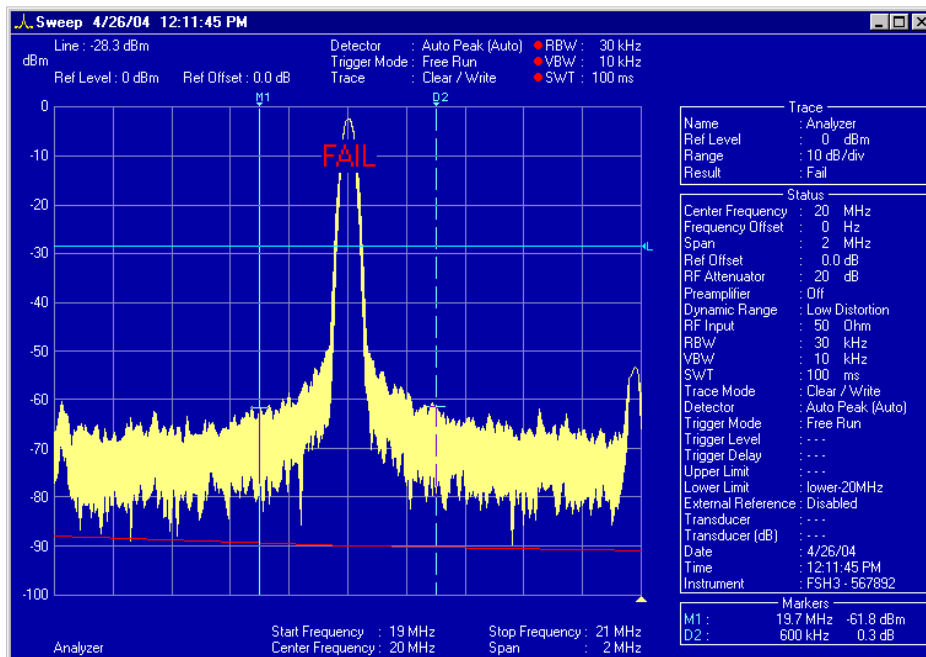

For information about the data in the Trace (or Status) block, select **Help – Index – Trace** (or **Status**) block, or refer to the settings on the spectrum analyzer (see operation manual).

To change a sweep window to your preference, various view and select features are available. However, not all features are available in all instrument modes.

- 2 Select **View – View Description** and type a description in the text box below the window (max. 10 lines).
- 3 Select **View - View Trace Information** to show or hide the trace block.

- 4 Select **View – View Status Information** to show or hide the status block.
- 5 Select **View – View Display Line** to show or hide the horizontal display line from the instrument.
- 6 Choose **Select - Markers** to select 1 up to 6 vertical markers. As a result, the Select Markers dialog box pops up allowing you to select or deselect the markers and X/Y-values you want to view in the sweep window.
- 7 Select **Options - Colors** to change window colors.
- 8 Select **Options - Description** to change the number of characters on a description line.
- 9 To change window titles, select **Options - Titles**.

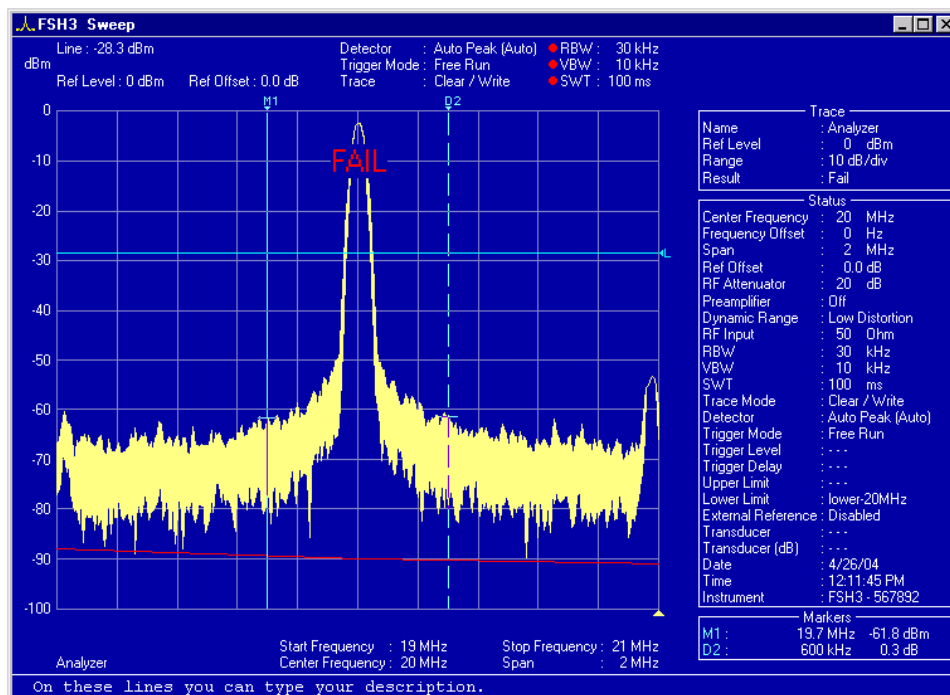



Tip

To change sweep parameters, place the mouse cursor on the Trace or Status block and double click the left mouse button.

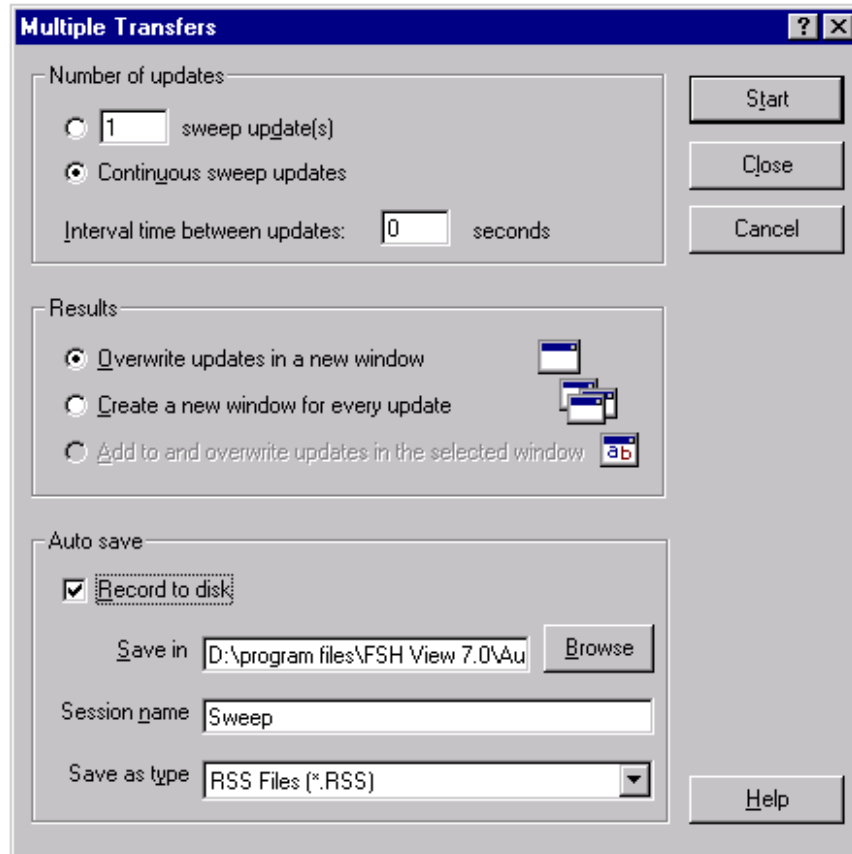
- 10  Click to read sweeps repeatedly. A dialog box appears allowing you to select options for multiple sweep transfers.



- 11 Choose **Continuous sweep updates** to read sweeps continuously.
- 12 Choose **Add to and overwrite updates in the selected window** to add a second sweep in the window, which will be overwritten continuously by the newly read sweep.
- 13 Enable **Record to disk** to automatically save read sweeps onto disk. Click  to get further What's This help.
- 14  Click to read and display sweeps repeatedly.
- 15  Click or press **Esc** to stop reading new sweeps.

Changing Sweep Settings

Select **Options – Sweep Settings**, or double click in the trace or status block. As a result, a dialog box pops up allowing you to:

- change the unit and range of the sweep in the active window;
- view the reference trace (if available from the instrument memory);
- view the upper/lower limit line from the instrument or select a new upper/lower limit line from file.

For more information, click the  help.

Zooming In and Out on a Trace

Drag with the mouse in the graph to select and zoom in on the part of the trace you want to enlarge.



Click to zoom in on a trace.

Use the scroll bars to select the part you want to view.



Click to zoom out on a trace (undoes one 'zoom in' step).



Click to reset zooming (undoes all 'zoom in' steps).

Inserting Sweep Data into a Spreadsheet

- 1 Click on the sweep you want to insert.
- 2 Select **Edit - Copy Data** to copy the sweep data to the clipboard.
- 3 Switch to a spreadsheet program.
- 4 Open or create a worksheet and place the cursor where you want to insert the data.
- 5 Select **Edit - Paste** to insert the data into the worksheet with the numerical readings arranged in columns.
- 6  Click to save your spreadsheet.

Transferring Instrument Datasets

- 1  Click to transfer datasets to and from the instrument. As a result, the Dataset Control dialog box pops up.

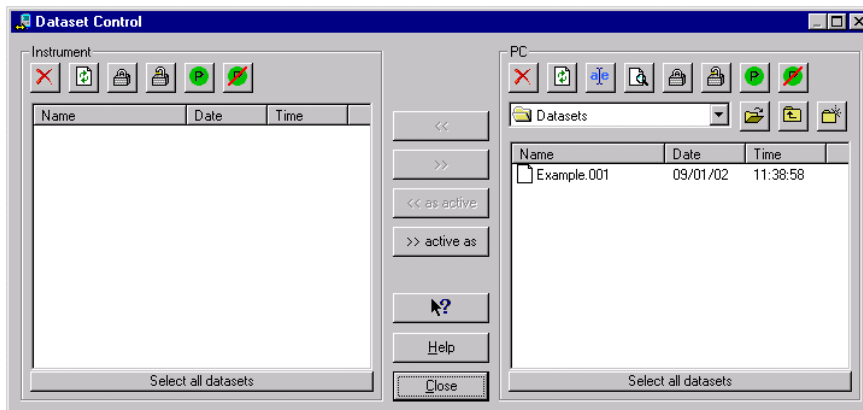

Saving Datasets to the PC

First, save a dataset in the instrument (default DATASET.000) by pressing the buttons **Save**, **F1**, and **F1** on the instrument.

- 2  Click to refresh the **Instrument** list. As a result, the datasets appear in the instrument frame list.

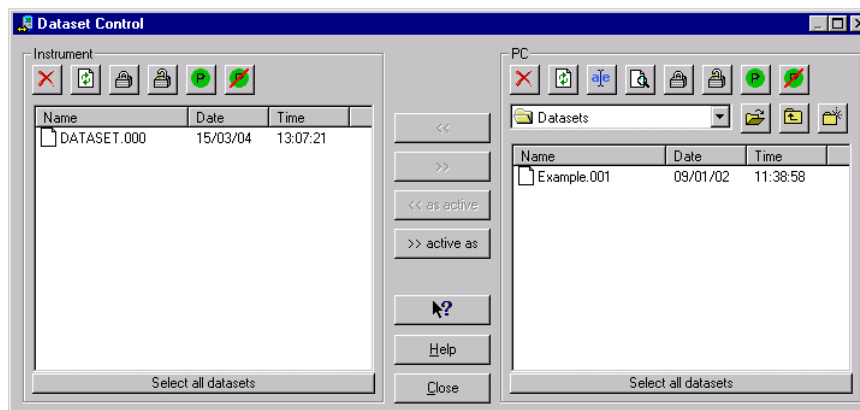

- 3 Select **DATASET.000** from the **Instrument** list.

 Click to select all datasets from the list.

- 4 Select a subdirectory from the **PC** frame where to store the dataset file(s).

Notice that the default directory is **\\FSH View\\Datasets**.

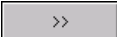
- 5  Click to transfer the selected dataset to the PC.

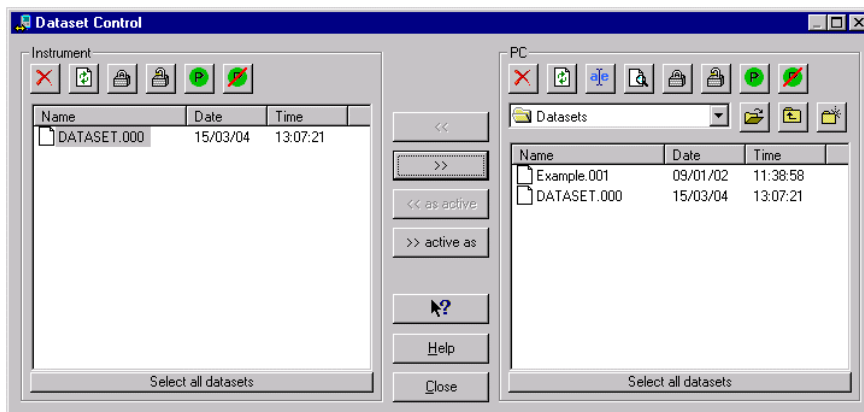



- 6 Select **DATASET.000** from the **PC** list.

- 7  Click to preview the selected dataset in a window or double click on the name.

Click  to close the preview window.

Uploading Datasets to the Instrument

- 8  Click and rename the selected dataset into DATASET.001 for example.

- 9  Click to lock the selected dataset; see lock sign in front of the name.

Note

A locked dataset cannot be deleted in the instrument.

- 10  Click to make the selected dataset the preset dataset; see preset sign in front of the name.

Note

A preset dataset is automatically locked (preset property overrides locked property).

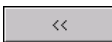
- 11  Click to transfer the selected dataset to the instrument.

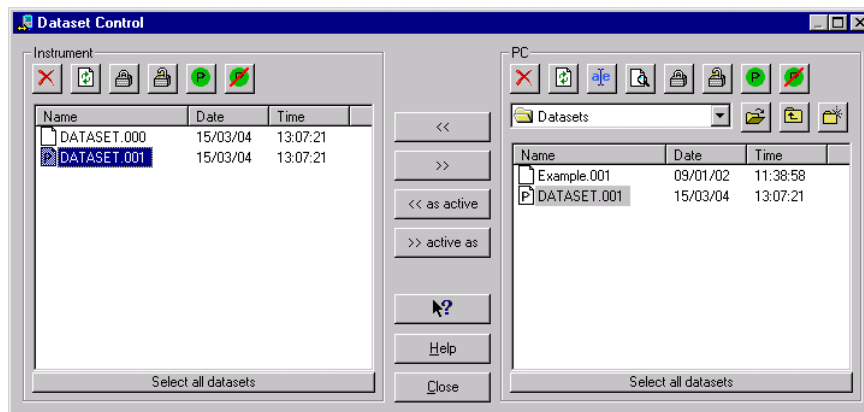

- 12 Select the locked **DATASET.001**, for example, from the **Instrument** list.

Using FSH View, you can delete locked datasets in the instrument.

- 13  Click to delete the selected dataset. As a result, a dialog box pops up for confirmation.

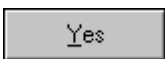
- 14  Click to confirm the delete action.

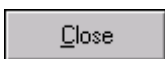
- 15  Click to close the Dataset Control dialog box.

Using Cable Models for Distance To Fault

Transferring cable models to the instrument is possible only if DTF is available in the instrument.

- 1  Click to transfer cable models to and from the instrument. As a result, the Cable Model Control dialog box pops up.

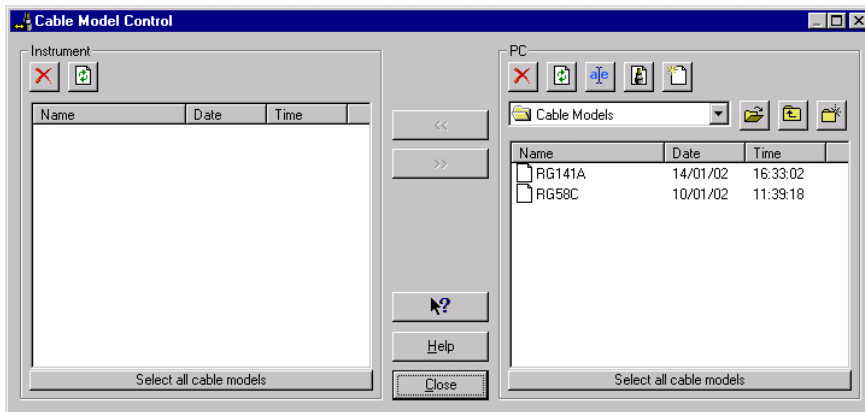

Uploading Cable Models to the Instrument

- 2 Select **RG141A** from the PC list, for example.
- 3  Click to transfer the selected cable model to the instrument.

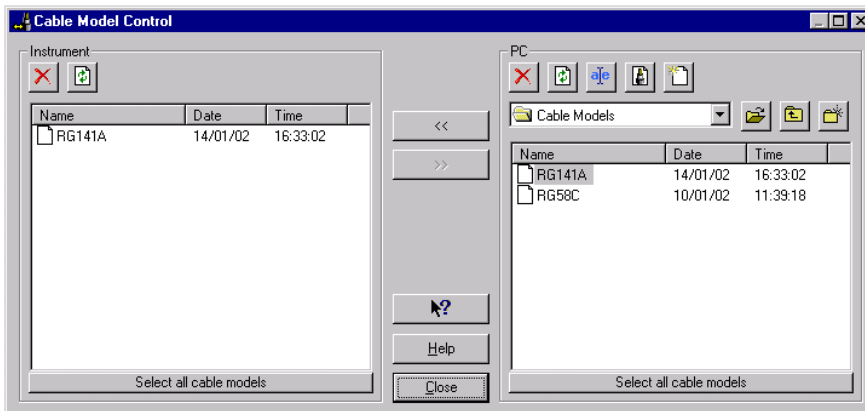

Editing Cable Models



- 4 Select **RG141A** from the **PC** list.
- 5  Click to edit the selected cable model file. As a result, the Cable Model Editor dialog box pops up.

Cable Model Editor - D:\program files\FSH View 7.0\Cable Models\RG141A.rsc [?] [X]

Cable Model Name: .RSC [v]
Description (optional):
Propagation Velocity: Absolute (m/s) [v]

	f (MHz)	a (dB/m)		f (MHz)	a (dB/m)
1	1	0.0112	11		
2	10	0.0361	12		
3	50	0.0886	13		
4	100	0.128	14		
5	200	0.1837	15		
6	400	0.269	16		
7	700	0.3609	17		
8	900	0.4101	18		
9	1000	0.4429	19		
10			20		

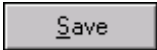
[New] [Open] [Save] [Close] [Sort] [Help]





- 6 Change the cable model characteristics to your preference.
- 7 Change the **Cable Model Name** to RG141B, for example.
- 8  Click to save the changes. As a result, a dialog box pops up allowing you to browse for a different folder, if you want to.
Notice that the default folder is:
FSH View\Cable Models
- 9  Click to save to file.
- 10  Click to close the Cable Model Editor dialog box.

Tip

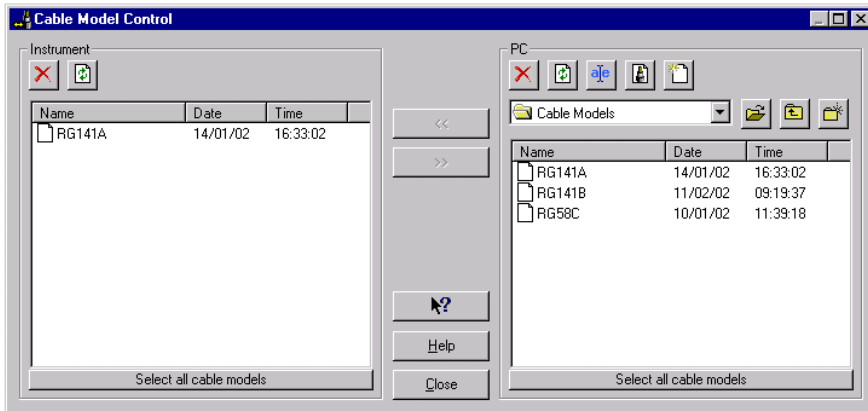

Click to create a new cable model file.



- 11 Select **RG141A** from the **PC** list, for example.
- 12  Click to delete the selected cable model file.
- 13  Click to select all cable models from the list.
- 14  Click to transfer the selected cable models from the instrument to the PC folder.
- 15  Click to close the Cable Model Control dialog box.

Using Limit Lines

- 1  Click to transfer limit lines to and from the instrument. As a result, the Limit Lines Control dialog box pops up.

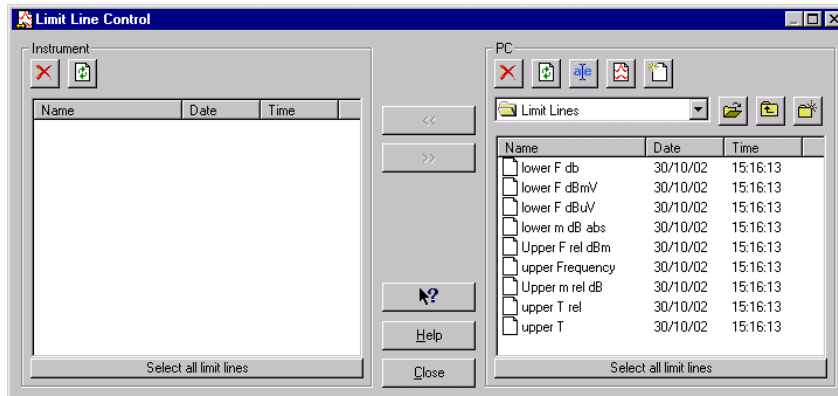

Uploading Limit Lines to the Instrument

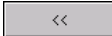
- 2 Select **lower F db** from the PC list, for example.
- 3  Click to transfer the selected limit line to the instrument.

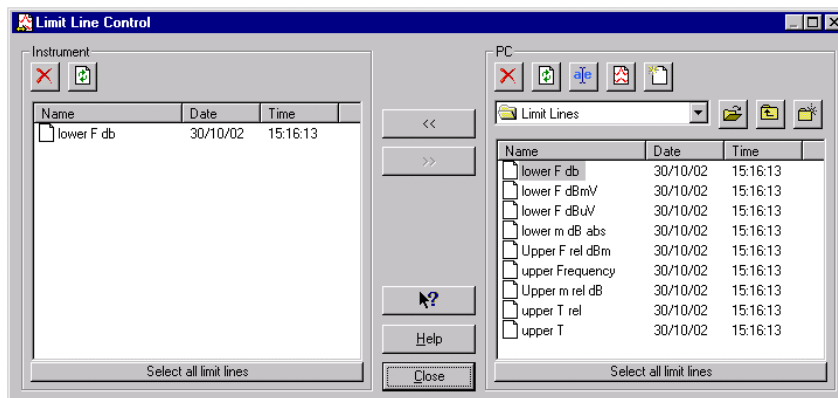

Editing Limit Lines

- 4 Select **lower F db** from the PC list.

- 5  Click to edit the selected limit line file. As a result, the Limit Line Editor dialog box pops up.

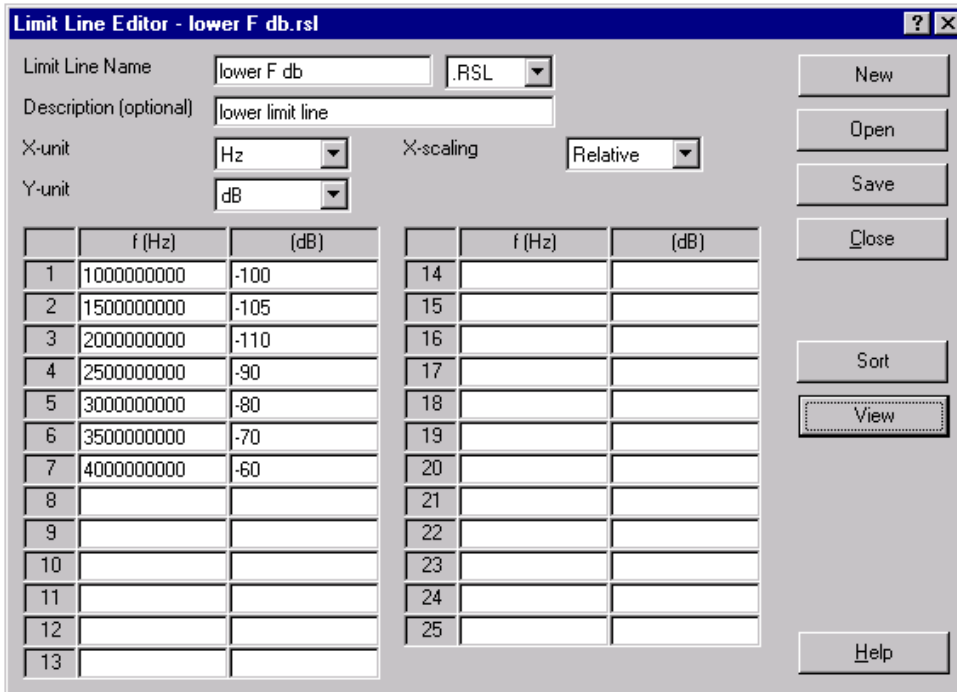

Limit Line Name: lower F db .RSL

Description (optional): lower limit line

X-unit: Hz X-scaling: Relative

Y-unit: dB



	f (Hz)	(dB)		f (Hz)	(dB)
1	1000000000	-100	14		
2	1500000000	-105	15		
3	2000000000	-110	16		
4	2500000000	-90	17		
5	3000000000	-80	18		
6	3500000000	-70	19		
7	4000000000	-60	20		
8			21		
9			22		
10			23		
11			24		
12			25		
13					

- 6 Change the limit line characteristics to your preference.

Tip

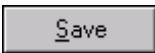

Click to preview the limit line.

- 7 Change the **Limit Line Name** to **lowlimit F db**, for example.
- 8  Click to save the changes. As a result, a dialog box pops up allowing you to browse for a different folder, if you want to.
Notice that the default folder is:
FSH View\Limit Lines
- 9  Click to save to file.
- 10  Click to close the Limit Line Editor dialog box.



Tip

Click to create a new limit line file.

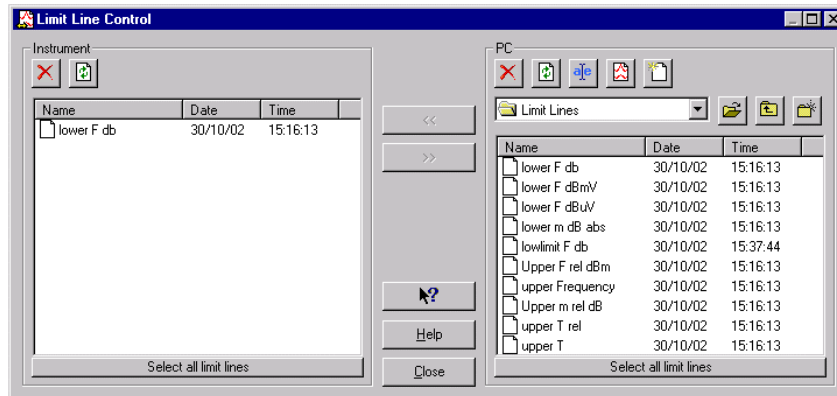

11 Select **lower F db** from the **PC** list, for example.

12  Click to delete the selected limit line file.

13  Click to select all limit lines from the list.

14  Click to transfer the selected limit lines from the instrument to the PC folder.

15  Click to close the Limit Line Control dialog box.

Using Transducer Factors

- 1  Click to transfer transducer factors to and from the instrument. As a result, the Transducer Control dialog box pops up.

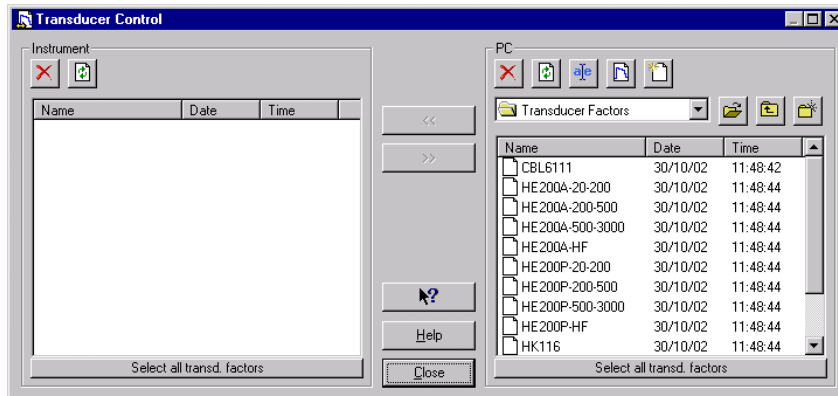

Uploading Transducer Factors to the Instrument

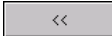
- 2 Select **CBL6111** from the **PC** list, for example.
- 3  Click to transfer the selected transducer factor to the instrument.

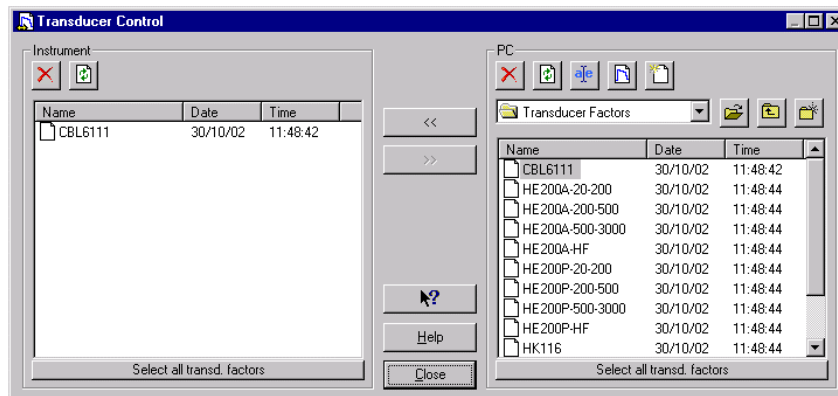

Editing Transducer Factors

- 4 Select **CBL6111** from the **PC** list.

- 5  Click to edit the selected transducer factor file. As a result, the Transducer Editor dialog box pops up.

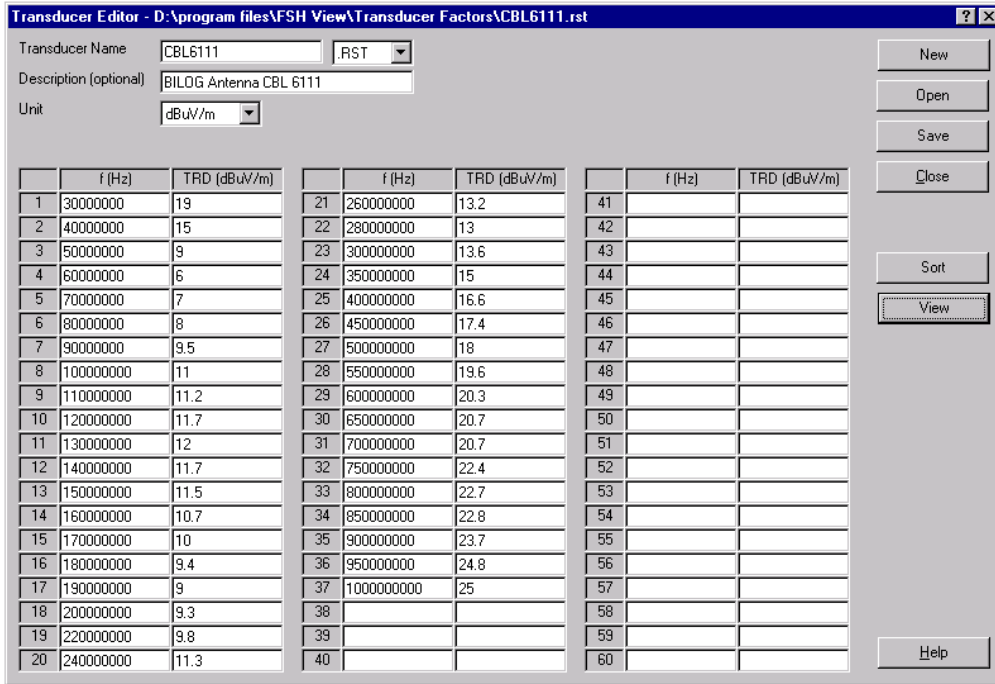

- 6 Change the transducer factor characteristics to your preference.

Tip



Click to preview the transducer factor.

- 7 Change the **Transducer Name** to **CBL6111A**, for example.

- 8  Click to save the changes. As a result, a dialog box pops up allowing you to browse for a different folder, if you want to.

Notice that the default folder is:

F\FSH View\Transducer Factors

- 9  Click to save to file.

- 10  Click to close the Transducer Editor dialog box.

Tip



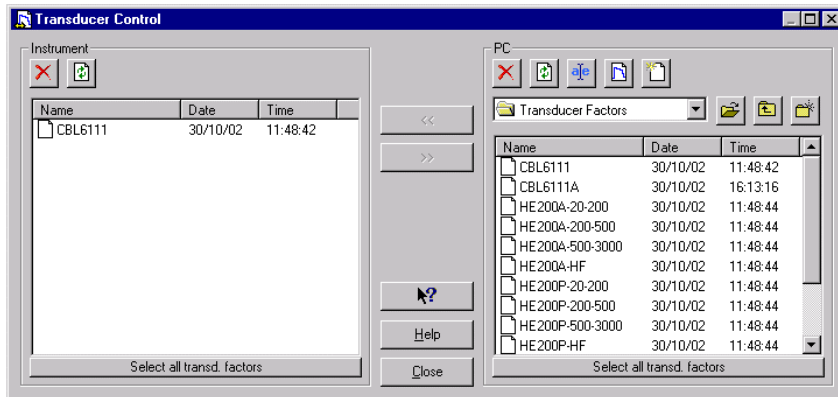

Click to create a new transducer factor file.

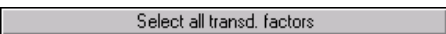

- 11 Select **CBL6111** from the **PC** list, for example.

- 12  Click to delete the selected transducer factor file.

- 13  Click to select all transducer factors from the list.

- 14  Click to transfer the selected transducer factors from the instrument to the PC folder.

- 15  Click to close the Transducer Control dialog box.

Using Channel Tables

- 1  Click to transfer channel tables to and from the instrument. As a result, the Channel Table Control dialog box pops up.

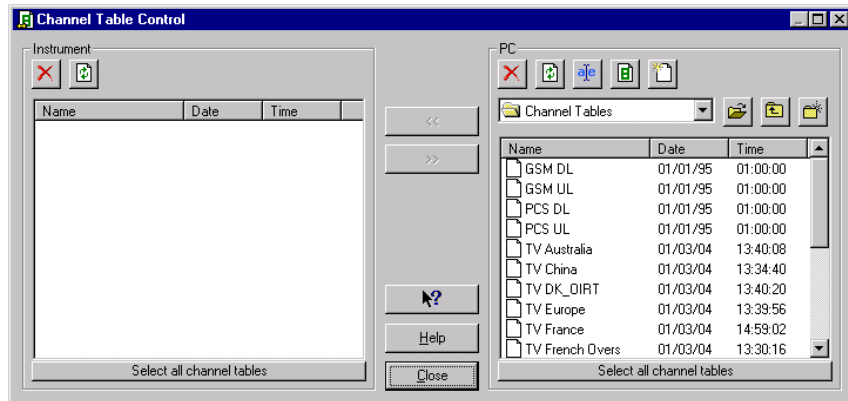

Uploading Channel Tables to the Instrument

- 2 Select **TV Europe** from the **PC** list, for example.
- 3  Click to transfer the selected channel table to the instrument.

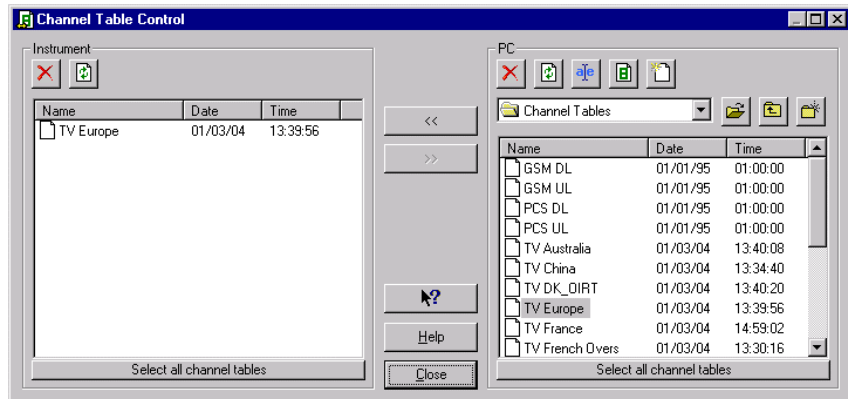

Editing Channel Tables

- 4 Select **TV Europe** from the **PC** list.



- 5  Click to edit the selected channel table file. As a result, the Channel Table Editor dialog box pops up.

Channel Table Editor - D:\program files\FSH View 7.0\Channel Tables\TV Europe.rsf ? X

Channel Table Name: TV Europe .RSF

Description (optional): TV Bands

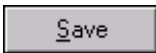
	band name	1st ch	f(1st ch) (MHz)	# chs	spacing (MHz)
1	VHF 1	2	50.5	3	7
2	VHF 3	5	177.5	8	7
3	S 2/3	102	118	1	10
4	Sp Ch lower	104	128.5	7	7
5	Sp Ch upper	111	233.5	10	7
6	Sp Ch hyper	121	306	21	8
7	UHF 4/5	21	474	55	8
8					
9					
10					
11					
12					
13					
14					
15					

- 6 Change the channel table characteristics to your preference.
- 7 Change the **Channel Table Name** to **TV Europe2**, for example.
- 8  Click to save the changes. As a result, a dialog box pops up allowing you to browse for a different folder, if you want to.
Notice that the default folder is:
\\FSH View\Channel Tables
- 9  Click to save to file.
- 10  Click to close the Channel Table dialog box.



Tip

Click to create a new channel table file.

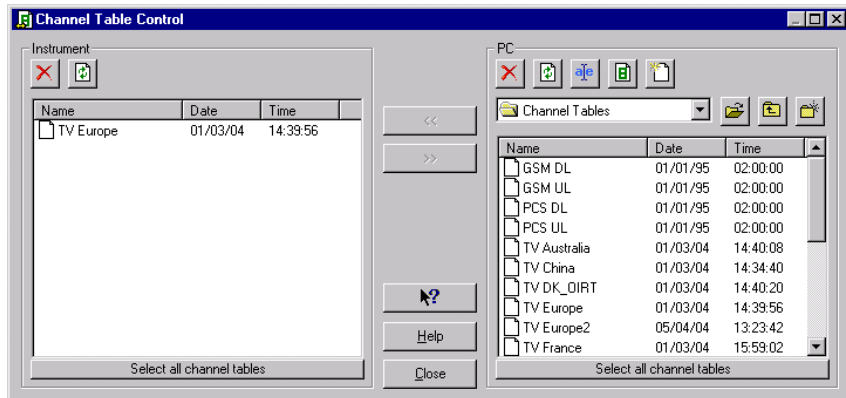

11 Select **TV Europe** from the **PC** list, for example.

12  Click to delete the selected channel table file.

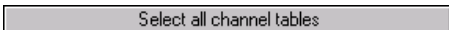
13  Click to select all channel tables from the list.

14  Click to transfer the selected channel tables from the instrument to the PC folder.

15  Click to close the Channel Table Control dialog box.

Printing Windows

Printing a Window

- 1 Click on the window you want to print.
- 2  Click to print the window.

Printing Multiple Windows on a Page

The Print Preview function enables you to preview a combination of windows on a page before printing.

- 3 Click on the window you want to print.
- 4  Click to preview the window on the page in the Print Preview window.

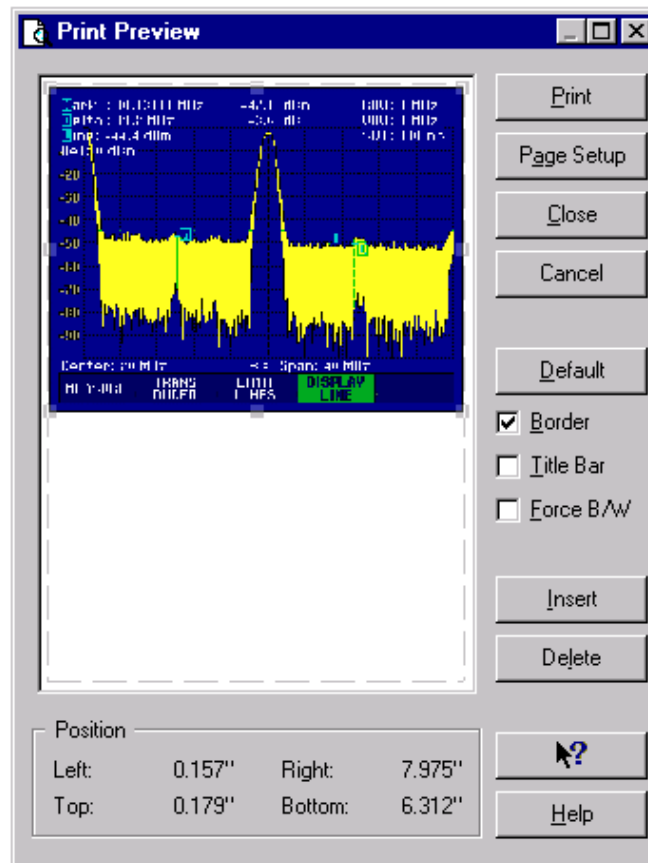

- 5 Check **Border** to add a border around the active window.
- 6 Check **Title Bar** to add the title of the active window.
- 7 Check **Force B/W** to switch from color to black & white (grey scale).
- 8  Click to add more windows on a page. A dialog box appears allowing you to select another window.

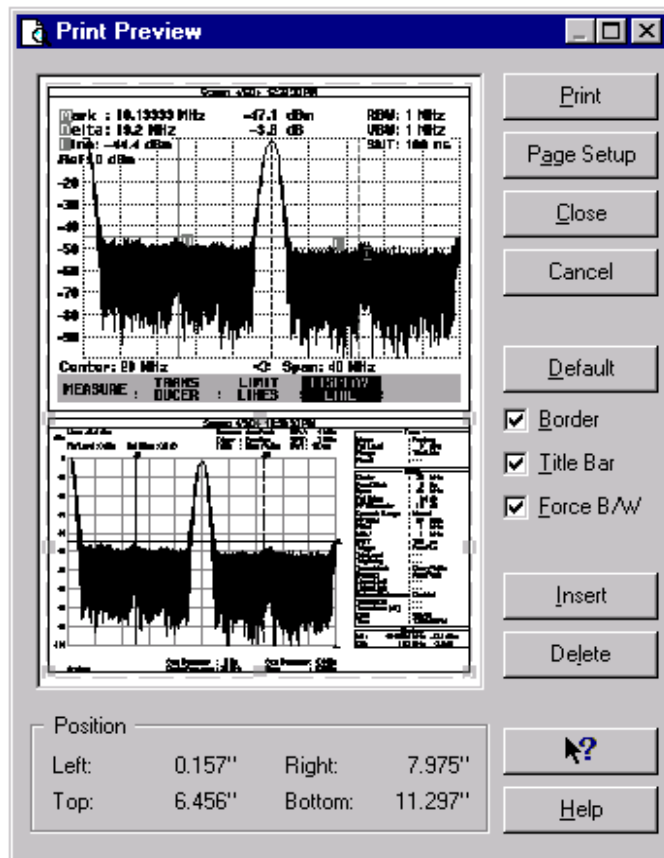

- 9  Click to start printing.
To change printer settings, select **File - Print Setup**.

Saving to a File

You can save one window to a file.

- 1 Click on the window you want to save.
- 2  Click to save to file. As a result, the File Save dialog box appears.
- 3 Enter a name for the file in the **File name** box.
- 4 Enter a file extension (file format) in the **Save as type** box.

The following file formats are supported:

- ◆ **BMP, PCX, PNG, WMF** for saving a graphical bitmap of a screen or sweep window
 - ◆ **CSV, TXT** for saving numerical sweep data (ASCII)
 - ◆ **RSC, RSD, RSF, RSL, RSS, RST** for saving to Rohde & Schwarz data formats:
 - **RSC** for Cable models
 - **RSD** for Datasets (sweep + settings)
 - **RSF** for Frequency Channel Tables
 - **RSL** for Limit lines
 - **RSS** for Sweeps
 - **RST** for Transducer factors
- 5  Click to save to file.

For more information on file formats, select **Index - File Formats** from the **Help** menu.

- 6  Click to open from file. As a result, the File Open dialog box appears.

Appendix A

Optically Isolated RS-232 Interface (optional)

Interface Connections

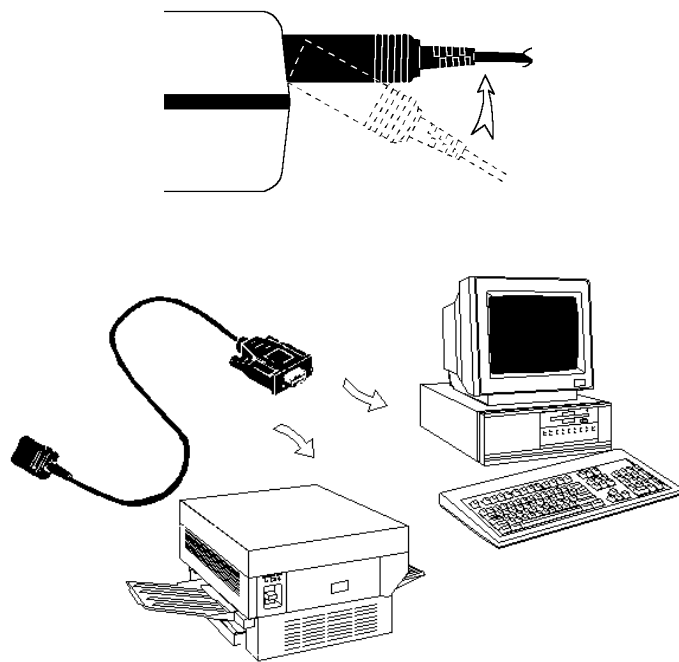

Interface Specifications

Type of interface:

RS-232 / EIA-232-D, optically isolated

States:

- SPACE = 0 Light
- MARK = 1 No light

Wavelength = 800 nm

RXD signal levels:

- SPACE = +10V to +4V Max. input = +15V
- MARK = -4V to -10V Min. input = -15V

Other signal levels:

- SPACE = +12V to +7V Max. input = +15V
- MARK = -7V to -12V Min. input = -15V

Handshake method:

XON/XOFF, software handshake only

Environmental:

- Meets requirements of MIL-T-28800D Type III, Class 3
- Temperature: Operating = 0 °C to +50 °C
Storage = -20 °C to +70 °C

Mechanical:

- Cable length = 1.5 m
- Weight = 0.14 kg

Interface Cable

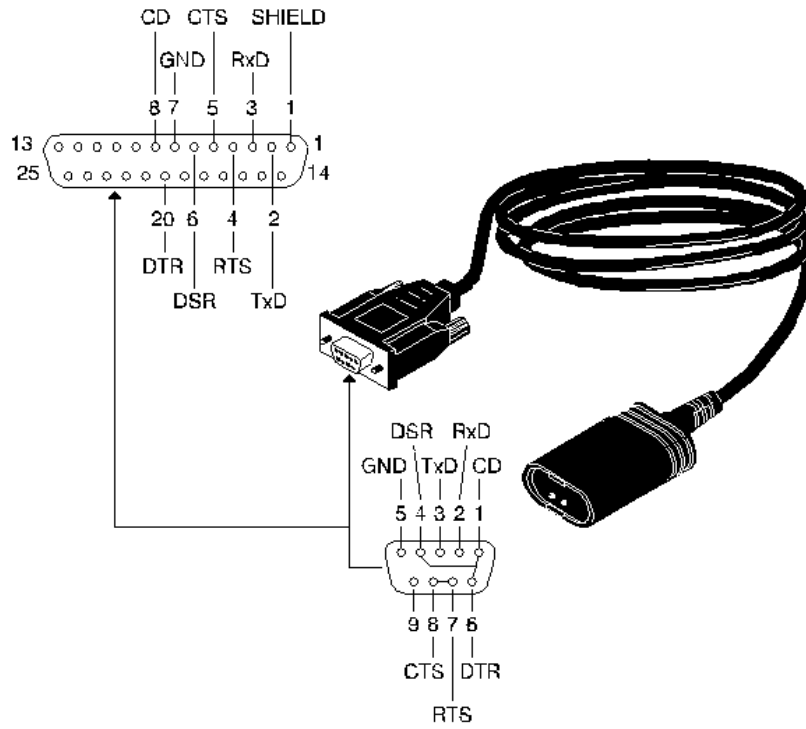

Index

A

Analyzing Sweeps	19
Autosave	21

B

Baud Rate	2
Bitmap-graphics	8
BMP	40

C

Cable Model	11, 26
Cable Model Editor	27
Cable RS-232	43
Channel Table	14, 35
Colors	18, 20
COM Port	2
Continuous sweep updates	21
Create Test Report	15
CSV	40

D

Dataset	10
Dataset Picture	16
Description	18, 19
Display Line	20
Distance To Fault (DTF)	26
Document	18

F

File opening	40
File saving	40

G

Graphics	8, 9
Greyscale	18

H

Help	3
------------	---

I

Installing FSH View.....	1
Instrument Cable Model	11
Instrument Channel Table	14
Instrument Dataset	10
Instrument Limit Line	12
Instrument Screen	8, 17
Instrument Transducer Factor	13
Interface Cable	43
Interface Connections.....	41
Interface Specifications	42

L

Limit Line	12, 29
Limit Line Editor	30
Lower limit line	22

M

Markers.....	20
Memory trace.....	22
Menu Commands	4
More Windows on a Page	39
Multiple Sweeps.....	21

O

Online Help	3
Open from file	40

P

PCX	40
PNG	40
Print Preview	38
Print Setup	39
Printing a Window	38
Printing Multiple Windows	38
Printing Windows	38
Print-Preview Window	38

R

Record to disk	21
Reference trace.....	22
RS-232 Cable.....	43
RSC, RSD, RSF, RSL, RSS, RST	40
Running the FSH View Software.....	1

S

Saving to a File.....	40
Screen	8, 17
Screen Picture.....	15
Screen Window	18
Selection Window.....	40
Serial Cable.....	43
Show Datasets	16
Spreadsheet.....	22
Status block.....	18, 20
Sweep	9

T

Test Report.....	16
Titles	20
Toolbar Buttons	7
Trace	19
Trace block.....	19
Transducer Editor.....	33, 36
Transducer Factor	13, 32
TXT.....	40

U

Upper limit line.....	22
-----------------------	----

V

View limit line.....	30
View transducer factor.....	33

W

What's This help.....	3
Window	
Print Preview.....	38
Screen.....	18
Selection	40
WMF.....	40
Word	
Dataset Picture	16
Screen Picture	15
Wordprocessor.....	18
Worksheet	22

Z

Zooming.....	22
--------------	----